

Please note that the data given here has been taken from the online catalog. For comprehensive information and data, please refer to the user documentation at <http://www.download.phoenixcontact.com>. The General Terms and Conditions of Use apply to Internet downloads.

► Extract from the online catalog

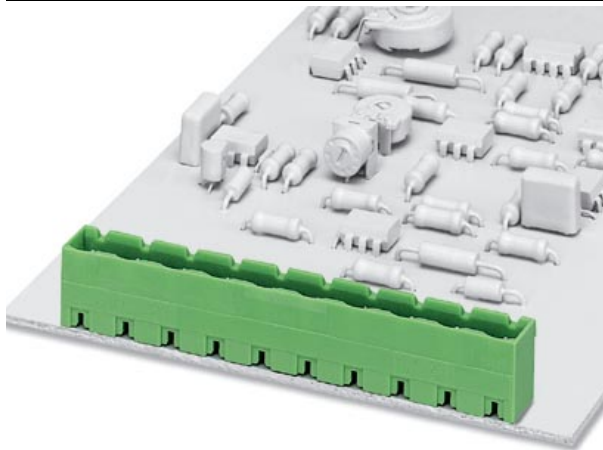

Header, nominal current: 12 A, rated voltage: 400 V, pitch: 7.5 mm, no. of positions: 7, mounting: Soldering

The illustration shows a 9-position version

Order No.	1766712
Ord designation	GMSTBVA 2,5/ 7-G
EAN	4017918032739
Pack	50 Pcs.
Customs tariff	85369010
Catalog page information	Page 191 (CC-2005)

► Technical data

Dimensions / positions

Pitch	7.5 mm
Dimension a	45 mm
Number of positions	7
Pin dimensions	1 x 1 mm
Hole diameter	1.4 mm

Technical data

Insulating material group	I
Rated surge voltage (III/3)	6 kV
Rated surge voltage (III/2)	6 kV
Rated surge voltage (II/2)	6 kV
Rated voltage (III/2)	400 V
Rated voltage (II/2)	1000 V
Connection in acc. with standard	EN-VDE
Nominal current I_N	12 A
Nominal voltage U_N	400 V
Maximum load current	12 A
Insulating material	PBT
Inflammability class acc. to UL 94	V0

► Certificates

Certificate logos



UL

Nominal voltage U_N	300 V
Nominal current I_N	10 A

CSA

Nominal voltage U_N	300 V
Nominal current I_N	10 A

► Drawings

Drilling diagram

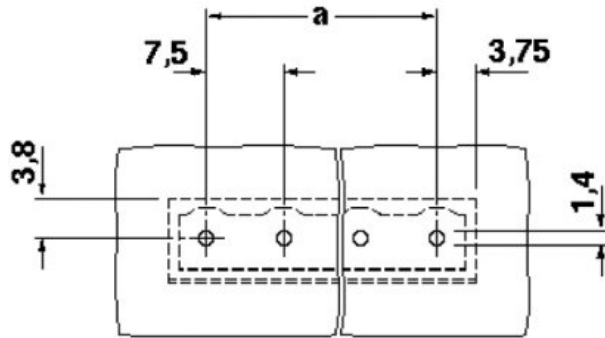

Dimensioned drawing

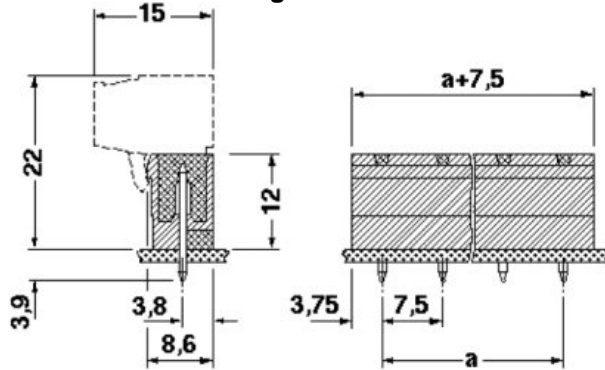

► Accessories

Item	Designation	Description
Assembly		
1755477	MSTB-BL	Keying cap, for forming sections, plugs onto header pin, green insulating material
Marking		
0804455	SK 7,5/3,8:FORTL.ZAHLEN	Marker card, self-adhesive, 10-section marker strip, 10 identical decades marked 1-10, 11-20 etc. up to 91-100, sufficient for 100 terminal blocks
Plug/Adapter		
1734401	CR-MSTB	Coding element, inserted into the recess in the header or the inverted plug, red insulating material

► Additional products

Item	Designation	Description
General		
1766932	GMSTB 2,5/ 7-ST	Plug component, nominal current: 12 A, rated voltage: 500 V, pitch: 7.5 mm, no. of positions: 7, type of connection: Screw connection
1737754	GMVSTBR 2,5/ 7-ST	Plug component, nominal current: 12 A, rated voltage: 500 V, pitch: 7.5 mm, no. of positions: 7, type of connection: Screw connection
1737864	GMVSTBW 2,5/ 7-ST	Plug component, nominal current: 12 A, rated voltage: 500 V, pitch: 7.5 mm, no. of positions: 7, type of connection: Screw connection

► Address

PHOENIX CONTACT GmbH & Co. KG
Flachsmarktstr. 8
32825 Blomberg
Germany
Phone +49 5235 3 00
Fax +49 5235 3 1200
<http://www.phoenixcontact.com>
Phoenix Contact
Technical modifications reserved;